



**Want to reach an engaged
woodworking and crafting audience?**

Then be a sponsor of

CHIEF'S SHOP

Plan of the Week

Contact Chris Hill for more details
chief@chiefs-shop.com
205-432-8013

CHIEF'S SHOP PLAN OF THE WEEK



SIMPLE WOODWORKING: NO-CUT PEDESTAL TABLE

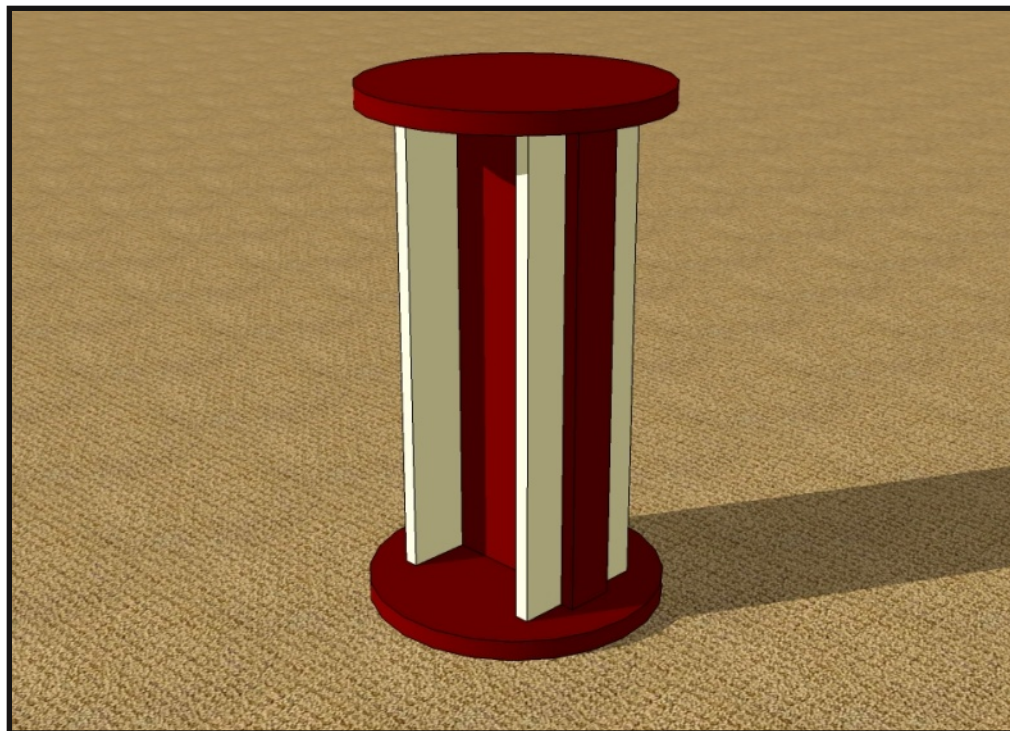

WHAT YOU'LL NEED



LUMBER

- 3 - 1 x 8 x 2
- 2 - 1 x 3 x 2
- 2 - 15-inch edge-glued round panels

(availability will vary)

HARDWARE/SUPPLIES

- 3" wood screws
- 1 1/4" pocket hole screws
- 1 1/4" brads
- pocket hole plugs
- wood glue
- paint/stain

TOOLS

- pneumatic nailer/hammer
- drill/driver
- Kreg Pocket Hole Jig
- clamps
- square

ABOUT THESE PLANS

On this first page you will see above the project complete. On the last page you'll find the finished outer dimensions. Be sure to read ALL of the project steps before you start.

To the right is a list of the Lumber, Hardware/Supplies, and Tools you will need to complete this project. A measuring tape and pencil are not included because that should be pretty standard and self explanatory.

Below What You'll Need is the Parts list. This also is included on the Parts Diagram page, which is the next to last page of this plan document.

Throughout these plans you'll find the icons below:

 **LAYOUT** This indicates a diagram detailing the dimensions of a project part and/or the placement for pocket holes, screws, nails, etc.

 **NOTE** Notes are the instructions for a particular step/section of the project.

 **TAKE CARE!** This indicates when to pay close attention to the diagrams, take precautions for safety, etc.

MORE PLANS

Want more Chief's Shop plans? Visit chiefs-shop.com and look through the Plans section. Be sure to "Like" Chief's Shop on facebook by heading over to [facebook.com/ChiefsShop](https://www.facebook.com/ChiefsShop).

PARTS

- Center Post (1) - 3/4 x 7 1/4 x 24
- Wings (2) - 3/4 x 7 1/4 x 24
- Trim (2) - 3/4 x 2 1/2 x 24
- Bottom (1) - 1 x 15
- Top (1) - 1 x 15

All parts are listed in actual dimensions. Refer to the Cutting Diagram on the last page of this plan as a guide for determining the specific board from which to cut the parts. Edge-glued round panels are commonly 1-inch thick, but may vary depending upon your supplier.

TAKE CARE!

This is a No-Cut project, which (clearly) means that no parts need to be cut. **HOWEVER**, as much as we would like it to be the case, not all boards are always created equal. Therefore, you must check each board for consistent length and for square on the ends. Make adjustments (cut the boards to square and the same length) if necessary. Be sure to use larger diameter edge-glued panels if you decide to make this table any taller.

LAYOUT

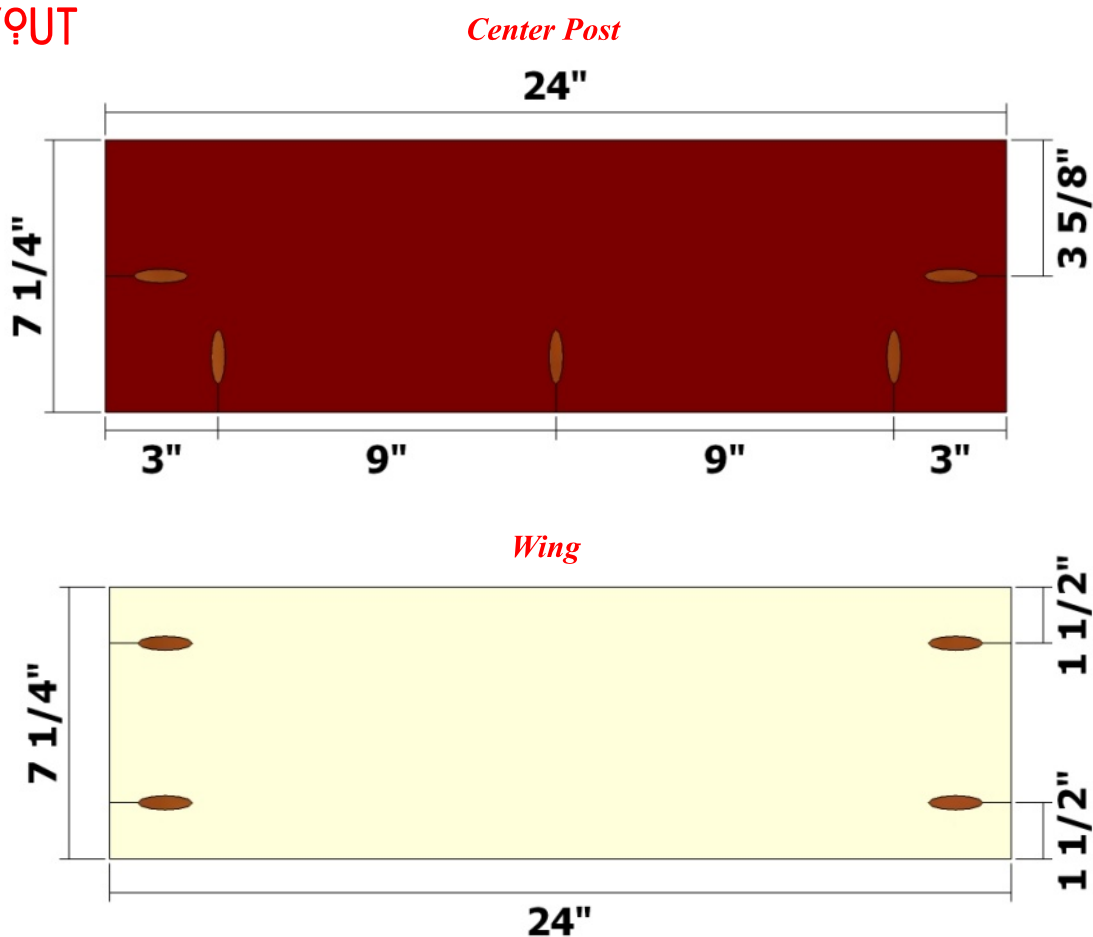

NOTE Use the layouts as guides for drilling pocket holes in the **Center Post** and **Wings**. Be sure to set your pocket hole jig and drill bit for 3/4-inch stock.

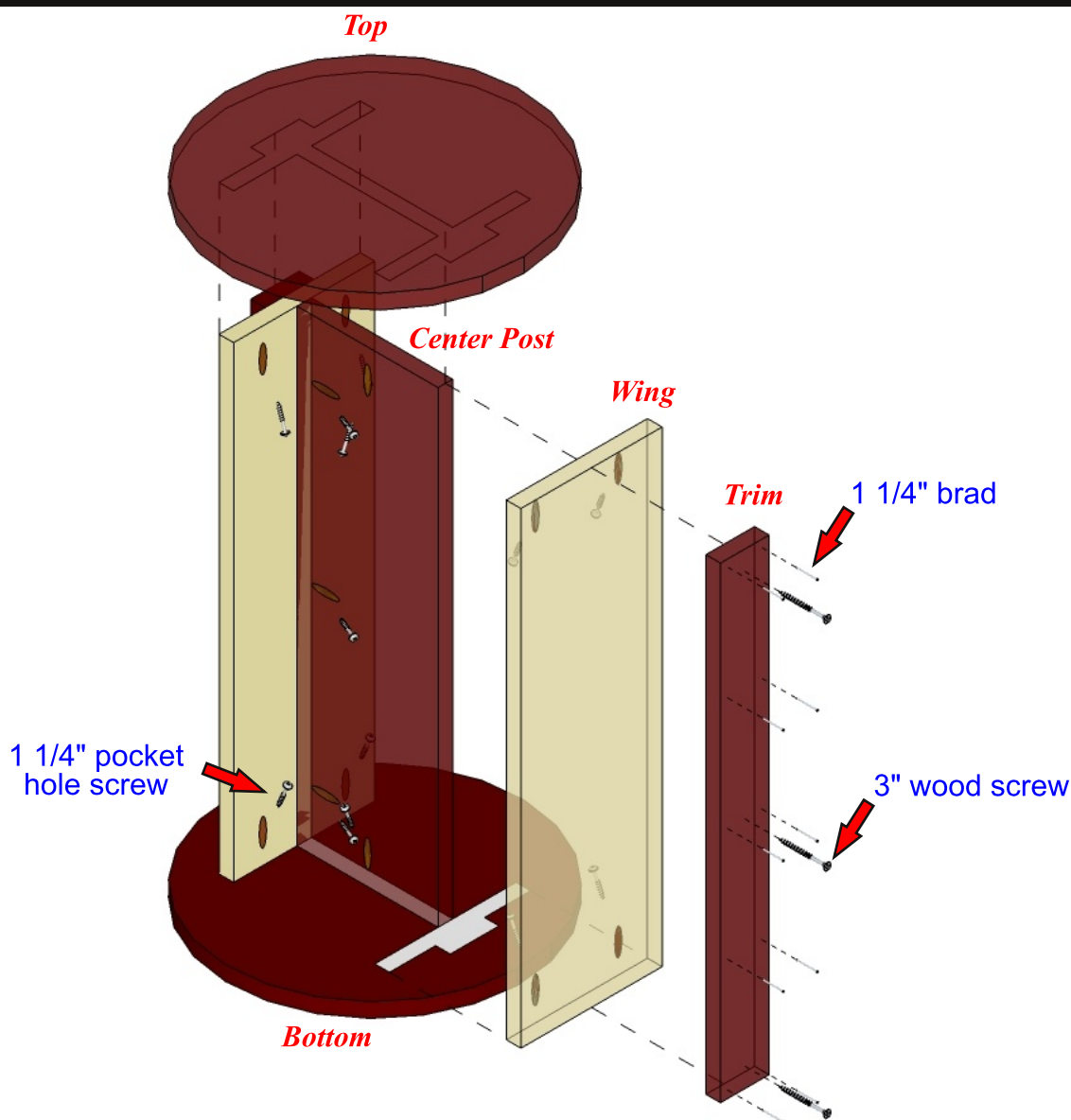

NOTE

Position the Trim pieces centered on the side of the Wings without pocket holes as shown, and attach using glue and 1 1/4-inch brads.

Position the Center Post with the pocket hole edge centered on one Wing as shown, and attach using glue and 1 1/4-inch pocket hole screws.

Position the other Wing/Trim Assembly centered on the other edge of the Center Post and attach using glue and 3-inch wood screws. Be sure to drill countersunk pilot holes for the screws, which are to be driven through the Trim and Wing and into the Center Post.

Find the center of the Bottom and Top (visit <https://www.chiefs-shop.com/html/videos.html>, Tips/Skills section for a tutorial), and mark a line from the center for reference when attaching the Wing/Center Post assembly. Position the Wing/Center Post Assembly centered on the Bottom and attach using glue and 1 1/4-inch pocket holes screws. Flip the assembly over, position it centered on the Top, and attach using glue and 1 1/4-inch pocket hole screws.



PARTS DIAGRAM



Center Post (1) - 3/4 x 7 1/4 x 24
Wings (2) - 3/4 x 7 1/4 x 24
Trim (2) - 3/4 x 2 1/2 x 24
Bottom (1) - 1 x 15
Top (1) - 1 x 15

All parts are listed in actual dimensions. Refer to the Cutting Diagram on the last page of this plan as a guide for determining the specific board from which to cut the parts. Edge-glued round panels are commonly 1-inch thick, but may vary depending upon your supplier.



1 x 8 x 2s

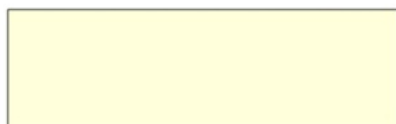

1 x 3 x 2s

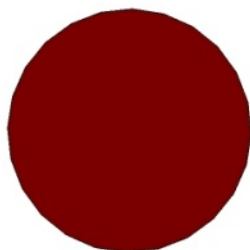

15-inch edge-glued
round panels

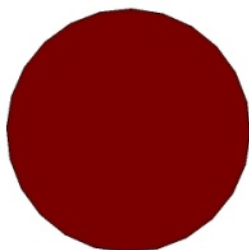

TAKE CARE!

Follow ALL SAFETY GUIDELINES AND RECOMMENDATIONS provided by the manufacturers of your tools, and any chemicals such as glue and finishes you use in this project. YOU are responsible for your safety, so use common sense when working in the shop!

